

KSH3-25D

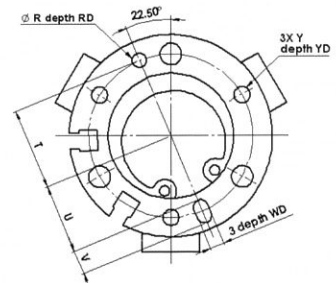
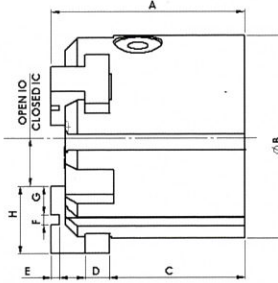
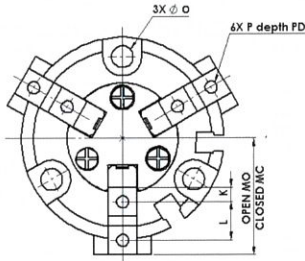
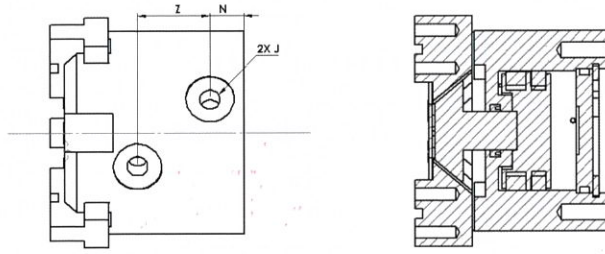

機種	A	B	C	D	E	F	G	H	IO	IC	L	K	MO	MC	O
KSH3-25D	40	42	28	5	1.7	2	6	14	10	7	8	3	24	21	4.5
機種	P	PD	R	RD	T	U	V	W	WD	Y	YD	Z	N	J	
KSH3-25D	M3X0.5	6	3	3	17	14.5	5	3	3	M4X0.7	6	15	7	M5X0.8	

(mm)

KSH3-32D/ 50D/ 63D/ 80D

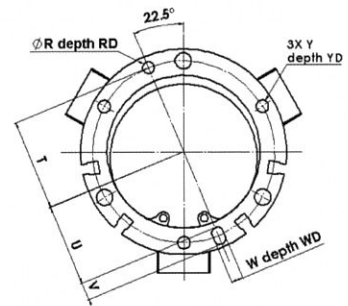
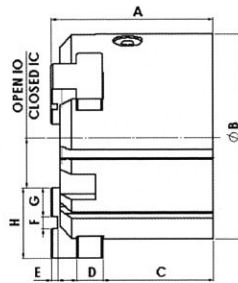
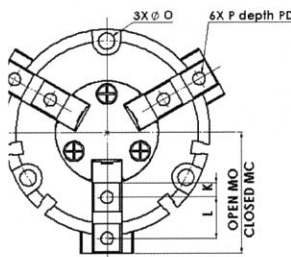
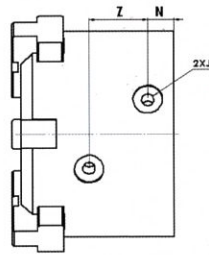

機種	A	B	C	D	E	F	G	H	IO	IC	L	K	MO	MC	O
KSH3-32D	44	52	30.5	6	2	2	9	20	12	8	11	4.5	32	28	4.5
KSH3-50D	55	70	37.5	9	2.2	4	10	24	17	11	14	5	41	35	5.5
KSH3-63D	66	86	44	11	3	6	11	28	23	15	17	5.5	54	43	6.6
KSH3-80D	82	106	56	12	4	8	12	32	31.5	21.5	20	6	63.5	53.5	6.6

機種	P	PD	R	RD	T	U	V	W	WD	Y	YD	Z	N	J
KSH3-32D	M4X0.7	8	3	3	22	19.5	5	3	3	M4X0.7	6	16	8	M5X0.8
KSH3-50D	M5X0.8	8	4	4	31	28	6	4	4	M5X0.8	10	20	9	M5X0.8
KSH3-63D	M6X1	10	5	5	38	34.5	7	5	5	M6X1	9	22	12	M5X0.8
KSH3-80D	M6X1	12	6	6	47.5	43.5	8	6	6	M6X1	12	27	13.5	M5X0.8

(mm)